

## Practice Test – Grade 5 Math Answer Key

Item Position	Item Type	TEKS Alignment	Maximum Number of Points	Correct Answer(s)
1	Multiple Choice	5.2.3.E	1	A
2	Multiple Select	5.1.2.B	2	C: 1.052 E: 1.003 See Appendix 1.1
3	Multiple Choice	5.2.3.K	1	B
4	Inline Choice	5.4.9.A	2	10, 18 See Appendix 1.2
5	Multiple Choice	5.2.4.D	1	D
6	Hotspot	5.3.4.H	2	See Appendix 1.3
7	Multiple Choice	5.2.3.G	1	D
8	Multiple Choice	5.4.9.C	1	B
9	Multiple Choice	5.2.4.B	1	D
10	Multiple Choice	5.1.4.F	1	C
11	Equation	5.2.3.K	1	10.25 See Appendix 1.4
12	Multiple Choice	5.3.6.A	1	A
13	Multiple Choice	5.2.3.B	1	D
14	Multiple Choice	5.1.2.A	1	C
15	Multiple Select	5.2.4.C	2	B: (0, 3) E: (4, 7) See Appendix 1.5
16	Multiple Choice	5.3.7.A	1	A
17	Multiple Choice	5.1.4.A	1	C
18	Hot Text	5.2.4.C	2	16, 13, 30 See Appendix 1.6
19	Multiple Choice	5.3.5.A	1	D
20	Multiple Choice	5.2.3.L	1	C
21	Multiple Choice	5.1.2.B	1	B
22	Multiple Choice	5.2.3.F	1	B
23	Hotspot	5.3.8.C	2	(1, 2) and (4, 8) See Appendix 1.7
24	Multiple Choice	5.2.3.G	1	B
25	Multiple Choice	5.4.10.E	1	D
26	Multiple Choice	5.1.4.F	1	A
27	Multiple Choice	5.2.3.E	1	C

Item Position	Item Type	TEKS Alignment	Maximum Number of Points	Correct Answers(s)
28	Inline Choice	5.3.8.B	2	4, 10, up See Appendix 1.8
29	Multiple Choice	5.2.4.B	1	A
30	Multiple Choice	5.4.9.C	1	C
31	Drag and Drop	5.2.3.H	2	7/8, 1/8 See Appendix 1.9
32	Multiple Choice	5.3.5.A	1	B
33	Multiple Choice	5.2.3.D	1	C
34	Multiple Choice	5.3.8.A	1	D

## Practice Test – Grade 5 Math

### Appendix

#### 1.1

Which numbers have a value less than 1.069?

Select **TWO** correct answers.

1.08

1.1

1.052

1.071

1.003

## 1.2

The list shows the number of minutes it took each student in a class to present a science project.

12 10 18 20 14 14 10 18 20 10 16 14 18 16 18

Cecelia is making the dot plot shown to display the data. Which two data points does Cecelia still need to add to the dot plot?

Science Project Presentations

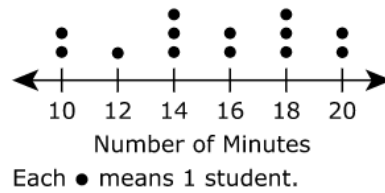

Choose the correct answer from each drop-down menu to complete the sentence.

Cecelia still needs to add one dot to  minutes and one dot to  minutes.

## 1.3

Which rectangular prisms have a volume of 64 cubic inches?

Select **TWO** correct answers.

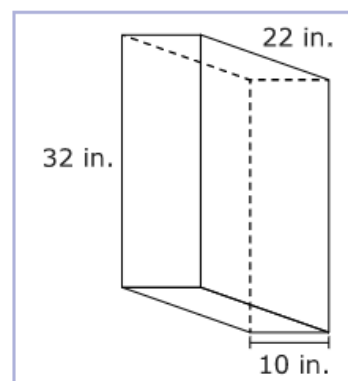
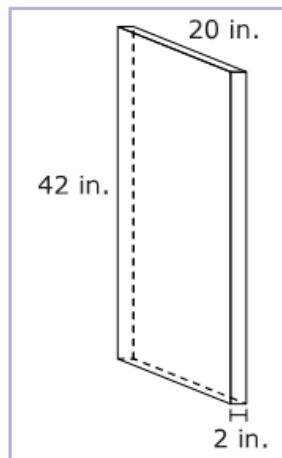
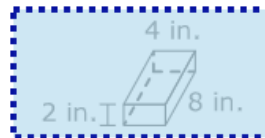
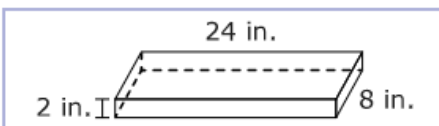

## 1.4

An expression is shown.

$$8\frac{1}{2} + 3 - 1\frac{1}{4}$$

What is the value of the expression?

Enter your answer in the space provided.

←	→	↶	↷	✖
1	2	3		
4	5	6		
7	8	9		
0	.	$\frac{\square}{\square}$		

## 1.5

The points on the grid represent values for  $y = x + 3$ .

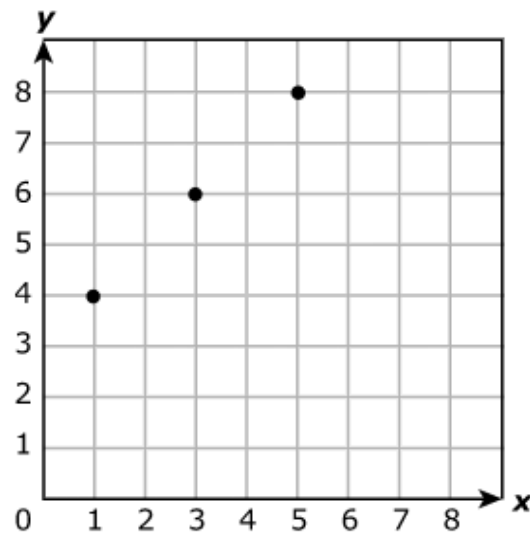

Which ordered pairs represent other points on the graph for this equation?

Select **TWO** correct answers.

(4, 1)

(0, 3)

(2, 6)

(5, 2)

(4, 7)

## 1.6

The values in the table represent the equation  $y = x + 6$ . Complete the table to represent the relationship between the values of  $x$  and  $y$ .

Move the correct answer to each box in the table. Each answer may be used more than once. Not all answers will be used.

4 13 16 18 25 30

$x$	$y$
10	16
13	19
24	30

## 1.7

Which points on the coordinate grid represent ordered pairs where the  $y$ -coordinate is 2 times the  $x$ -coordinate?

Select **TWO** correct answers.

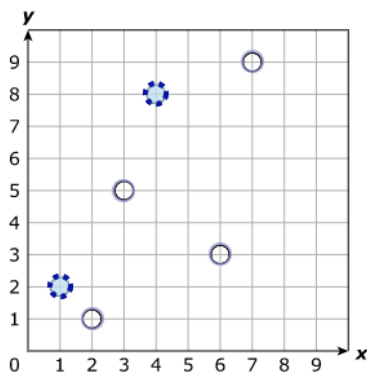

## 1.8

Complete the steps that could be used to plot the point at (4, 10) on a coordinate grid.

Choose the correct answer from each drop-down menu to complete the statements.

Step 1: Start at the origin.

Step 2: Move  to the right.

Step 3: Move  .

Step 4: Plot the point.

## 1.9

Beth and Noah shared a box of chocolates. The models are shaded to show the fraction of the box of chocolates each of them ate.

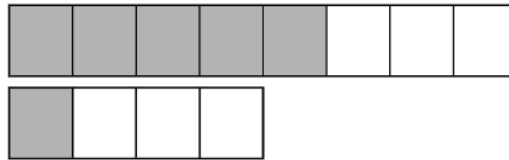

What fraction of the box of chocolates did Beth and Noah eat altogether? What fraction of the box of chocolates is left over?

Move the correct answer to each box. Each answer may be used more than once. Not all answers will be used.

1	2	4	5	7	8	12
---	---	---	---	---	---	----

Fraction  
Eaten

Fraction  
Left Over